

BG ПРАВА ТАВАНСКА СЪЛБА

HU MOLNÁR LÉPCSŐ

CH RAUMSPARTREPPE

IT SCALA FISSA SCALA FISSA

CS MLYNÁRSKÉ PŮDNÍ SCHODY

NL MOLENAARSTRAP

DE RAUMSPARTREPPE

PL SCHODY MŁYNARSKIE

ES ESCALERA MODULAR

RO SCĂRI FIXE

FR ÉCHELLE MEUNIÈRE

RU ЛЕСНИЦА "ДАЧНИЦА"

GB THE STAIR CASE

SK MLYNÁRSKE SCHODY

GR ΣΤΑΘΕΡΗ ΣΚΑΛΑ

UA СХОДИ СТАЦІОНАРНІ

HR MLINAR LJESTVE

MSU

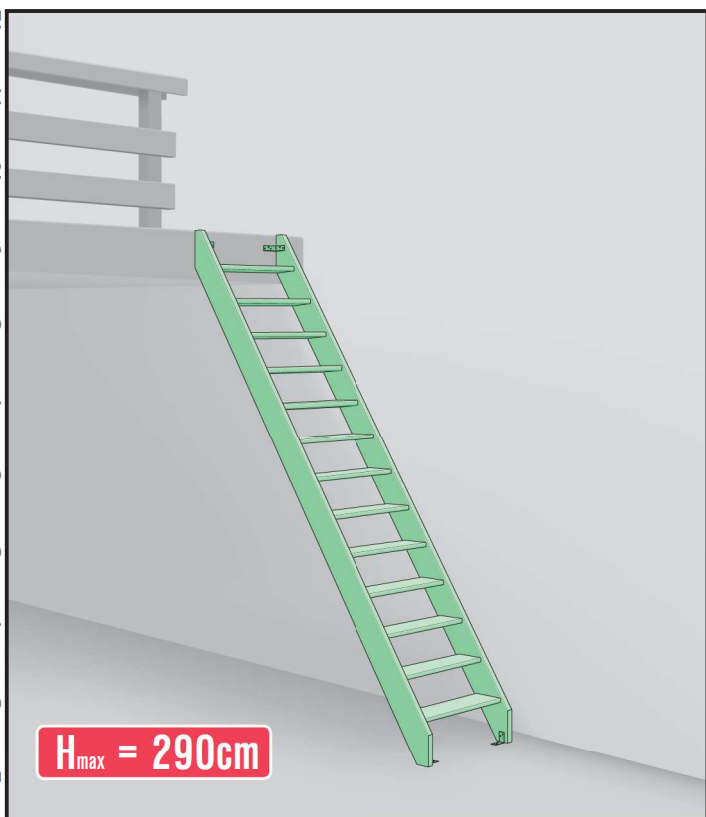

H_{max} = 290cm

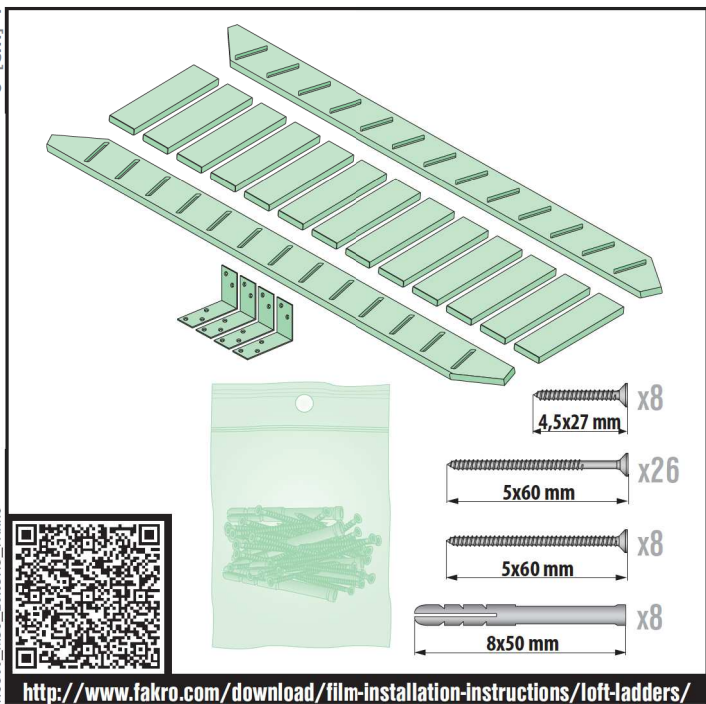



**WARNING! ACHTUNG!
U W A G A ! ATTENTION!
CUIDADO! ПРИМЕЧАНИЕ!**

CZ Montáž schodů je nutno provést v souladu s návodem. POZOR! Použití schodů v rozporu s návodem je zakázáno, může způsobit vážnou nehodu a má za následek ztrátu záruky a odpovědnosti výrobce.

DE Die Montage und Nutzung der Bodentreppe sollte gemäß der Anleitung durchgeführt werden. ACHTUNG! Die Nichtbeachtung der Anleitung ist verboten und kann schwere Unfälle verursachen und ist aus der Garantie ausgeschlossen. Der Hersteller übernimmt keine Verantwortung.

EE Pööninguluugi paigaldus ja kasutamine peab olema vastavuses lisatud juhenditega. TÄHELEPANU! Juhistele mitte vastav kasutamine on rangelt keelatud kuna võib põhjustada tõsise õnnetuse, see tühistab garantii ning muudab Tootja toote eest enam mitte vastutavaks.

ES La instalación y el uso de las escaleras se debe ejecutar de acuerdo con el manual de instrucciones. ¡PRECAUCIÓN! Está prohibida la utilización de la escalera que no sea conforme con el manual de instrucciones, porque puede causar un accidente grave, deshabilita la garantía y hace que el fabricante no se responsabilice.

FR L'installation et l'utilisation des escaliers doivent être effectuées conformément à l'instruction. ATTENTION! l'utilisation des escaliers contrairement à l'instruction est interdite, elle peut provoquer un accident grave, annulation de la garantie et manque de responsabilité du fabricant.

GB Installation and use of the loft ladder should be strictly in accordance with included instructions. CAUTION! Using the loft ladder in violation of the instructions is strictly forbidden, may result in a serious injury, will invalidate the Warranty and makes the Manufacturer no longer liable for the product.

HU A padlásfeljáró lépcső beépítése és üzemeltetése a beépítési/használati útmutató szerint kell, hogy történjen! FIGYELEM! A padlásfeljáró lépcső útmutatóval ellentétes vagy azzal nem megegyező módon történő használata tilos és balesetveszélyes, illetve súlyos balesettel járhat valamint garanciavesztést eredményez; a fentiekből adódó következményekért a gyártó nem vállal semmiféle felelősséget.

IT L'installazione e l'uso va fatto nel pieno rispetto delle istruzioni. ATTENZIONE! è assolutamente vietato l'utilizzo difforme alle istruzioni d'uso dato che può essere causa di gravi incidenti ed in ogni caso fa decadere la garanzia nonché qualsiasi responsabilità del produttore.

LT Montuojant ir naudojantis palėpės laiptais būtina laikytis nurodytų instrukcijų. ĮSPĖJIMAS: naudotis palėpės laiptais pažeidžiant instrukcijas griežtai draudžiama, nes tai gali sukelti rimtą nelaimingą atsitikimą, ir gamintojas turi teisę panaikinti garantiją ir nebeatsakyti už gaminį.

LV Bēniņu kāpņu uzstādīšana un lietošana veicama atbilstoši pievienotajām instrukcijām. UZMANĪBU! Kāpņu lietošana neatbilstoši instrukcijas prasībām ir stingri aizliegta, jo tā var izraisīt nopietnus nelaimes gadījumus, kā arī pārtrauc noteikto garantijas apkalpošanu un ražotāja atbildību par produktu.

NL Het is noodzakelijk dat montage en gebruik van de zoldertrappen conform de handleidingen uitgevoerd worden. LET OP! Gebruik van de zoldertrap is niet toegestaan wanneer deze niet conform de handleiding is gemonteerd. Dit kan gevaarlijke situaties veroorzaken. De garantie wordt in dit geval niet toegekend en de producent is niet verantwoordelijk voor de mogelijke gevolgen.

PL Montaż i użytkowanie schodów należy wykonywać zgodnie z instrukcją. UWAGA! użytkowanie schodów niezgodnie z instrukcją jest zabronione, może spowodować groźny wypadek, wyłącza gwarancję oraz powoduje brak odpowiedzialności producenta.

PT A instalação e o uso da escada devem ser de acordo com as instruções incluídas. ATENÇÃO! O uso da escada violando as instruções é estritamente proibido, pois isso pode causar um acidente grave, anula a Garantia e torna o Fabricante não responsável pelo produto

RO Instalarea și utilizarea scărilor trebuie efectuate conform instrucțiunilor. ATENȚIE! Încălcarea acestor instrucțiuni este interzisă deoarece duce la pierderea garanției și poate provoca accidente grave. Producătorul nu își asumă răspunderea pentru evenimentele produse ca urmare a încălcării instrucțiunilor de instalare și utilizare a scărilor.

RU Монтаж и эксплуатация лестницы должны проводиться согласно инструкциям производителя. ВНИМАНИЕ! Неправильная эксплуатация лестницы может привести к несчастному случаю, отменить гарантию производителя и снять с него ответственность.

SI Namestitev in uporaba podstrešja morajo biti v skladu z vključenimi navodili. OPOZORILO! Uporaba lestve podvozja v nasprotju z navodili je strogo prepovedana, saj lahko povzroči resno nesrečo, razveljavi garancijo in povzroči, da proizvajalec ne odgovarja več za izdelek.

SK Montáž a používanie schodov je potrebné vykonávať v súlade s návodom. POZOR! Používanie schodov v rozpore s návodom je zakázané, môže spôsobiť vážnu nehodu a má za následok stratu záruky a zodpovednosti výrobcu.

US Installation and use of the attic ladder should be in accordance with included instructions. WARNING! Using the attic ladder in violation of the instructions is strictly forbidden as it may cause a serious accident, it voids the Warranty and makes the Manufacturer no longer liable for the product.

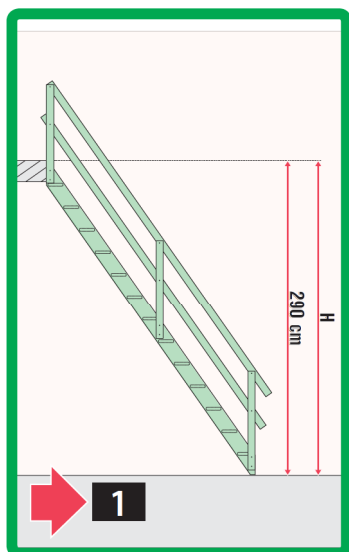
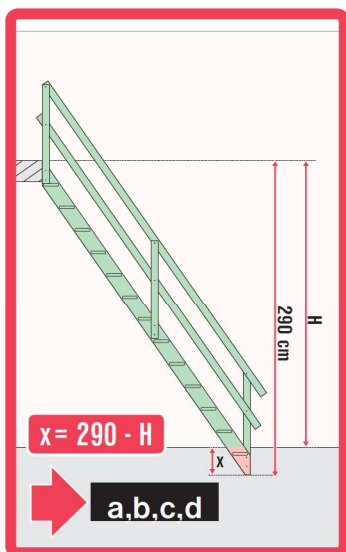
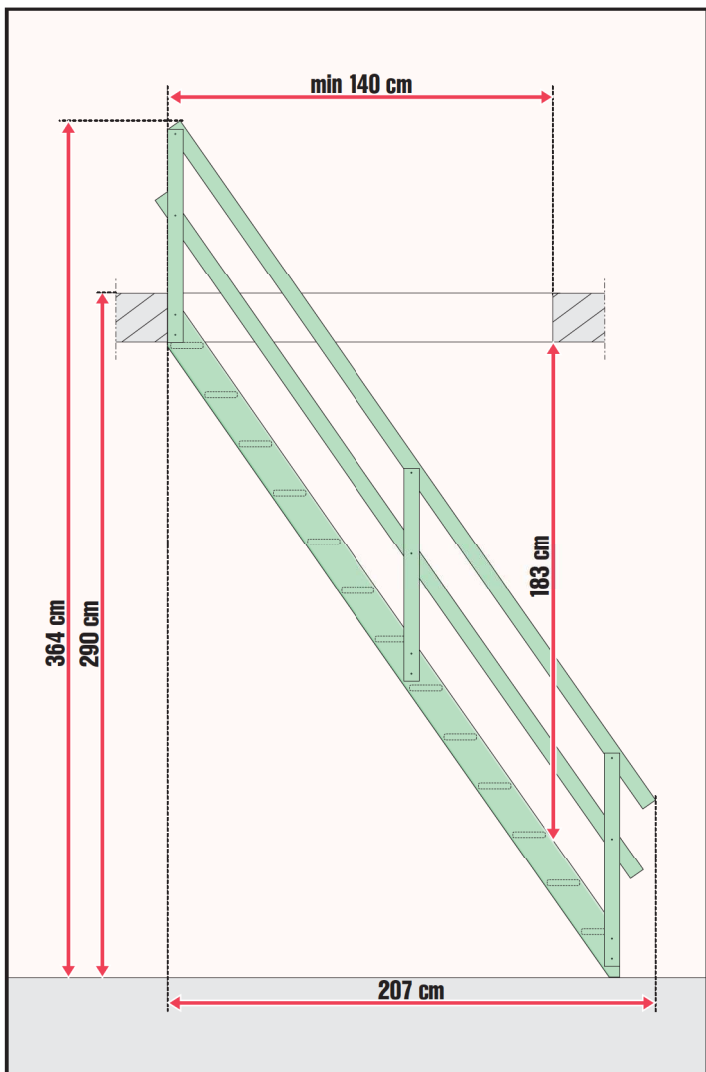
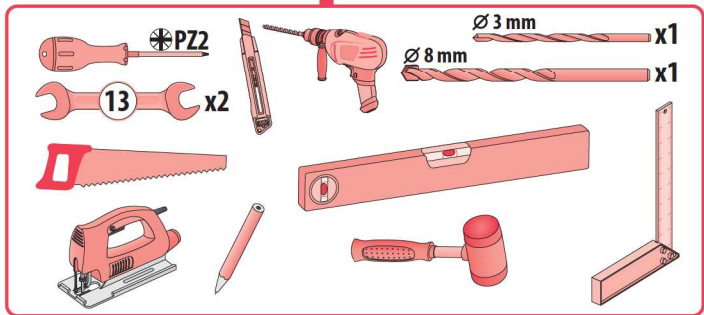
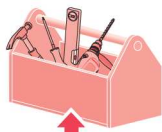

$$x = 290 - H$$

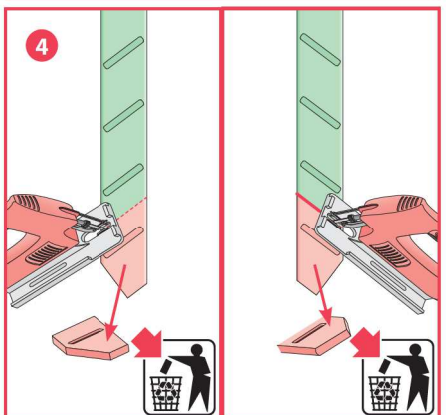
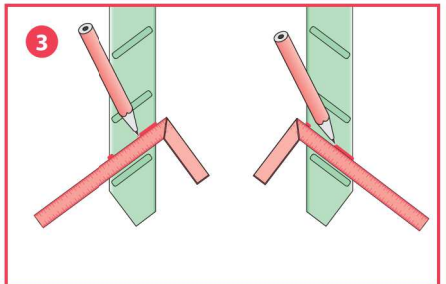
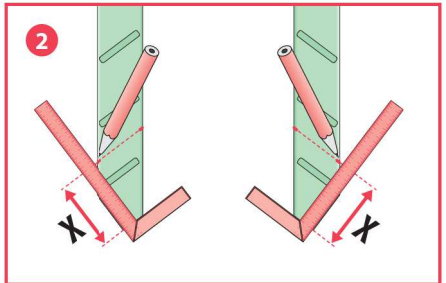
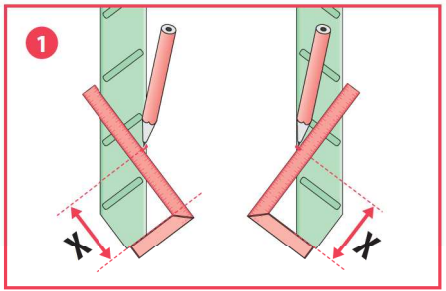
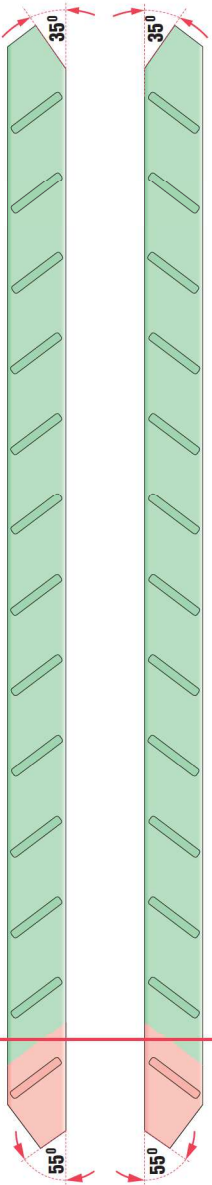
**a**

b

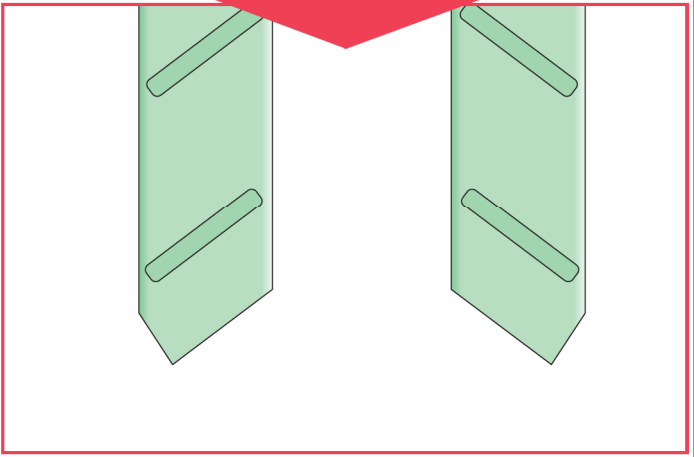
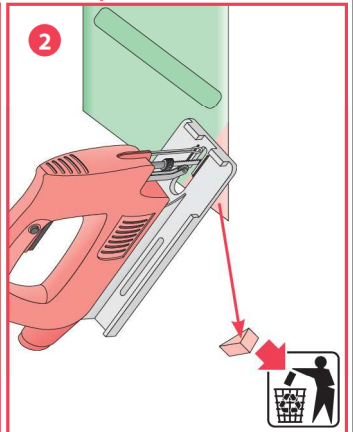
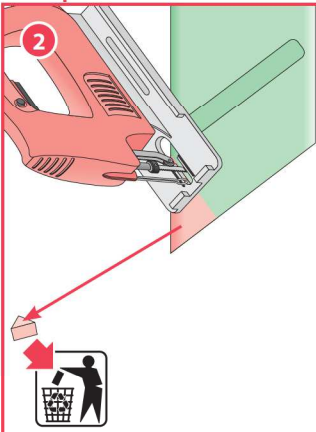
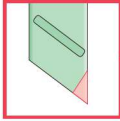
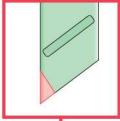
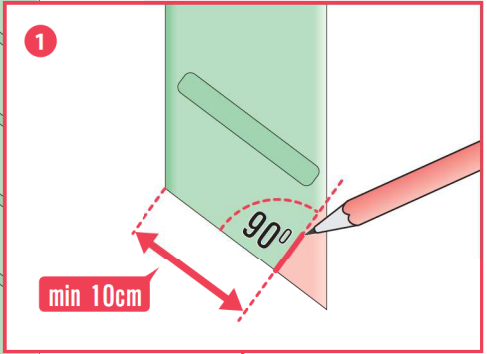
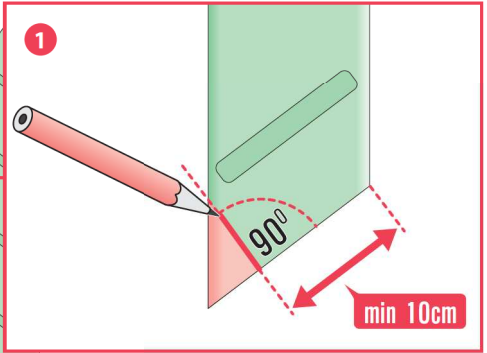

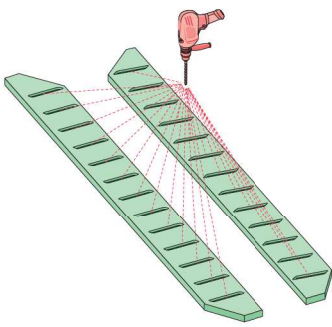
1

Ø 3 mm

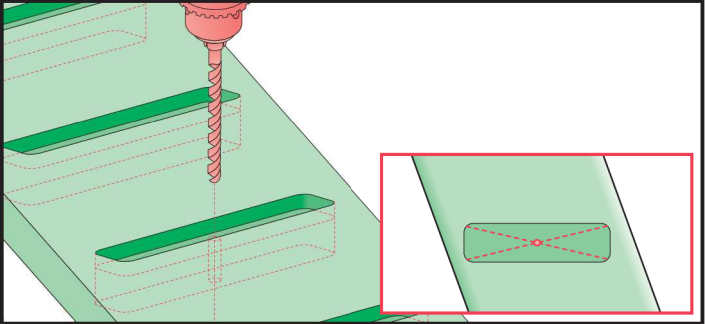
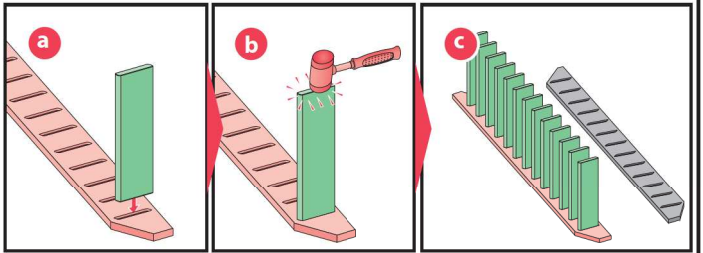
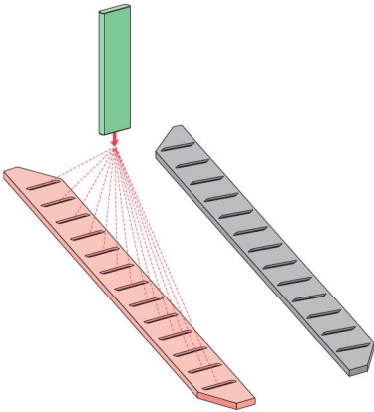
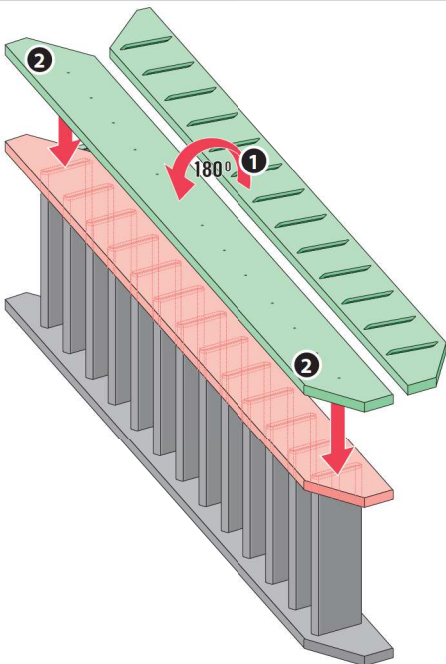
**2****3**

4

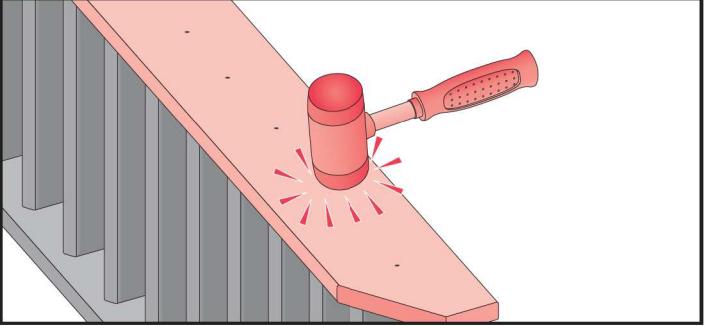
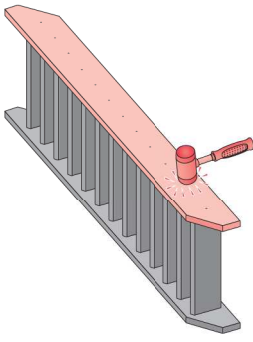

5

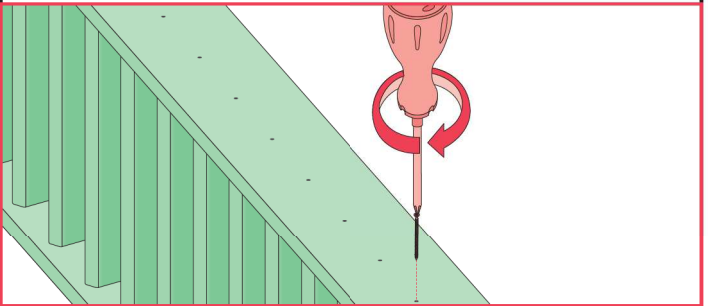
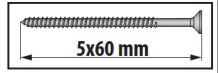
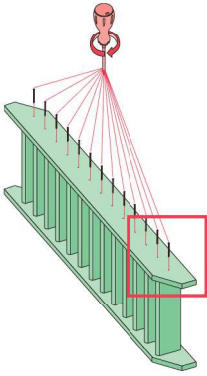

6

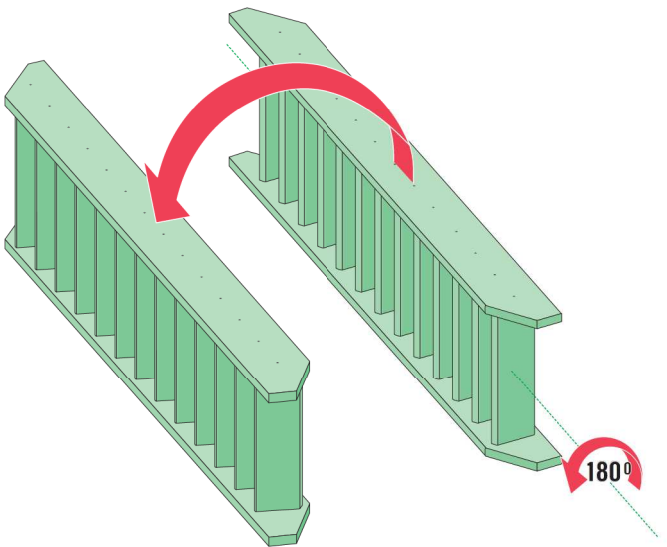

7

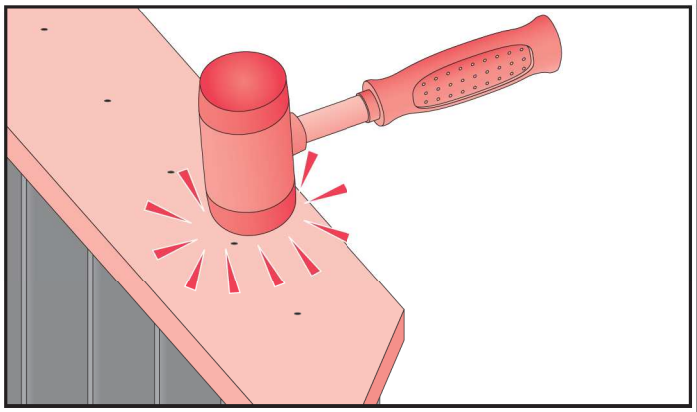
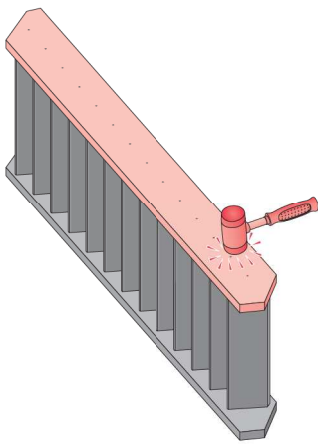

8

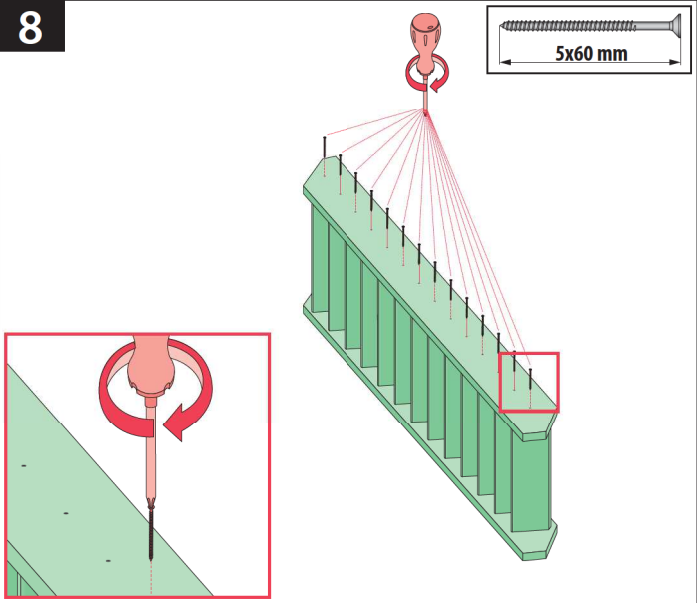
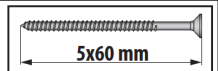

9

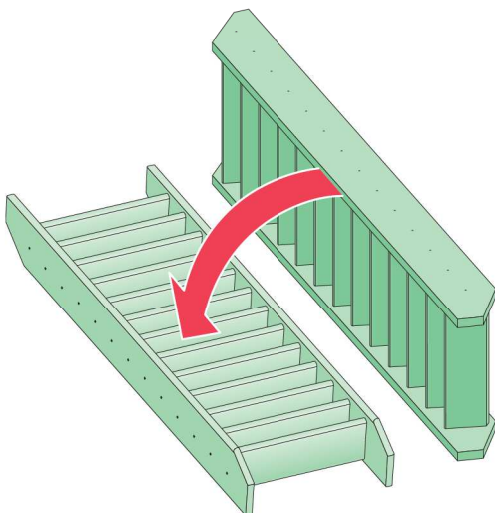

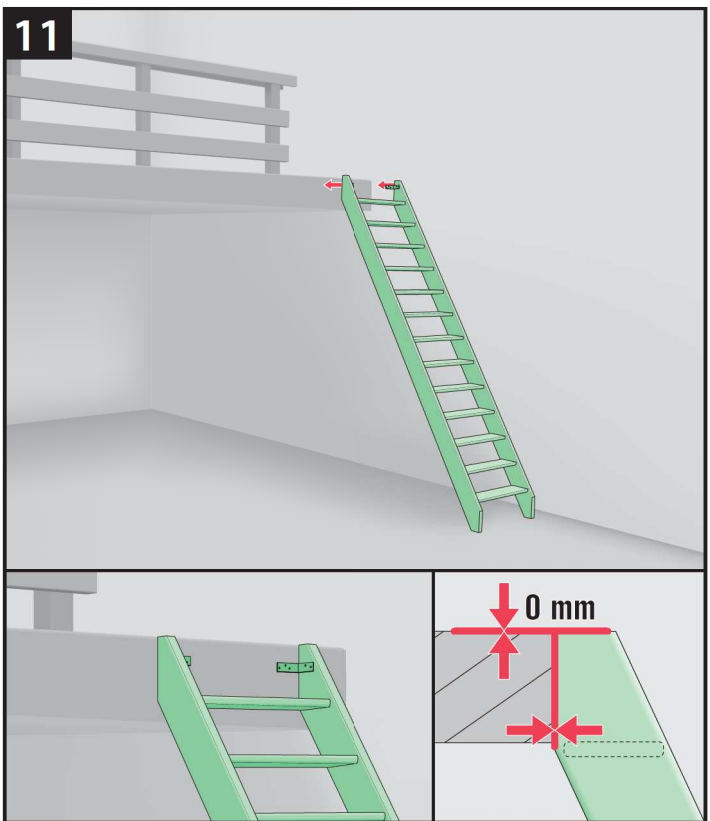
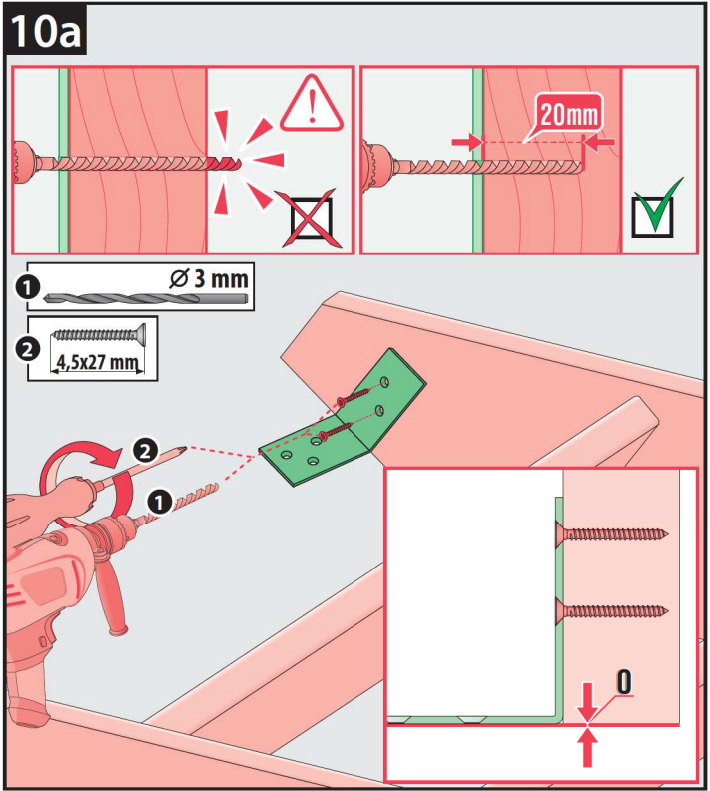
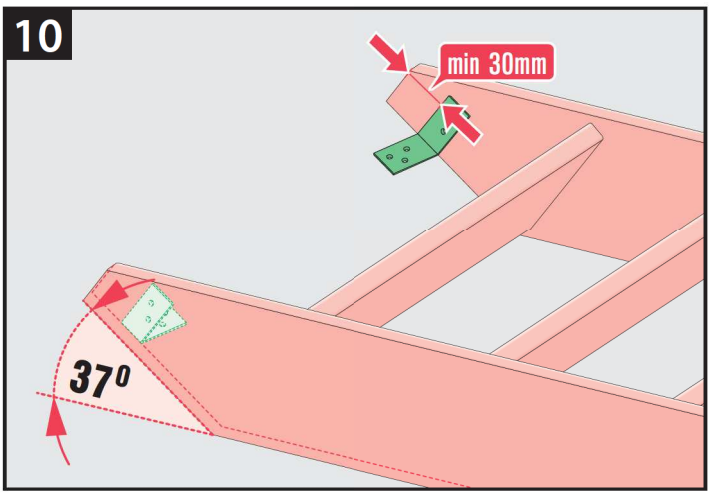

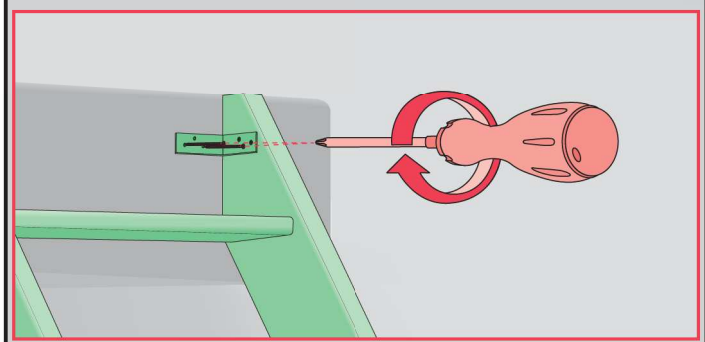
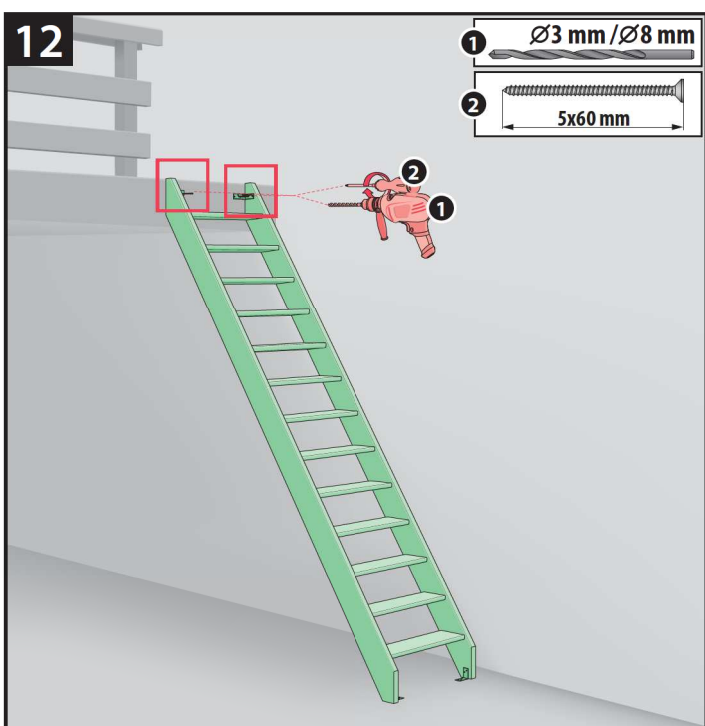
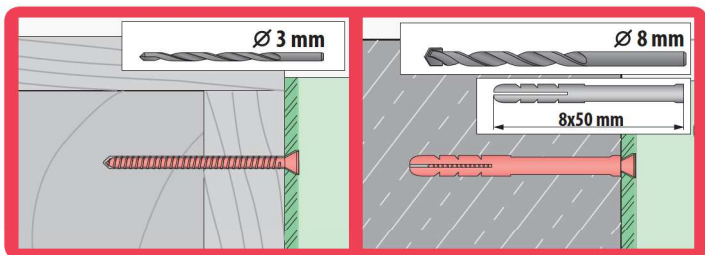

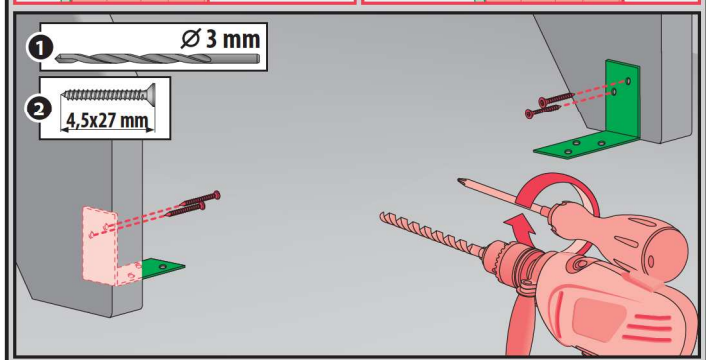
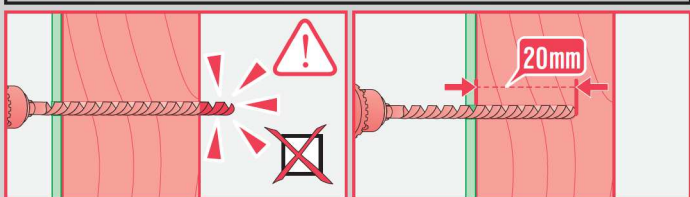
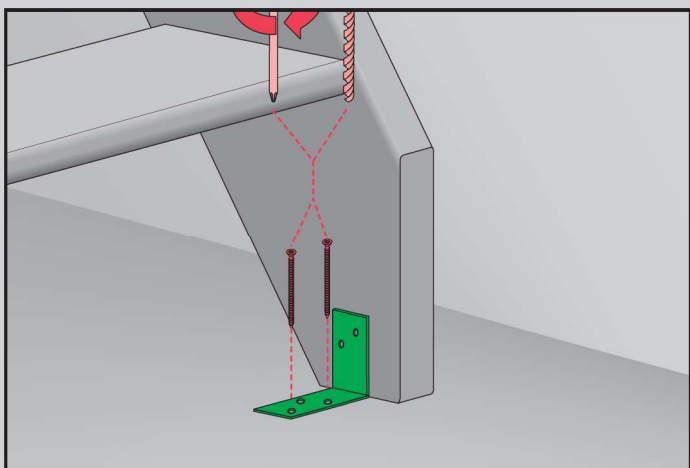
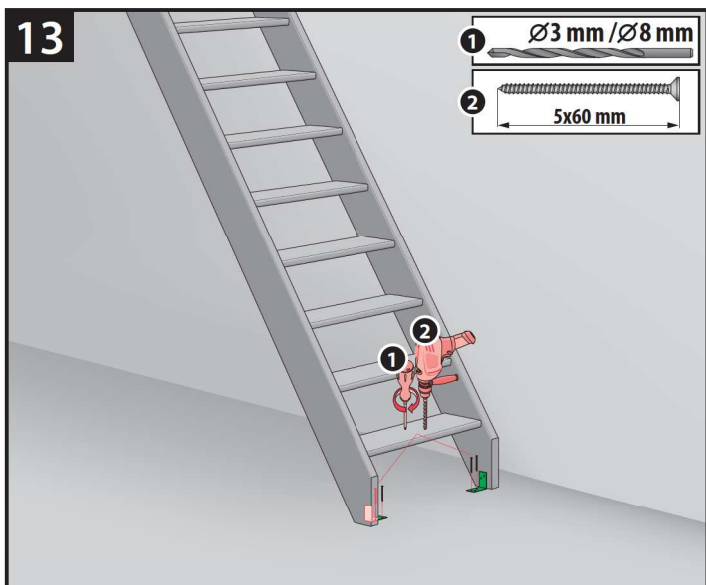
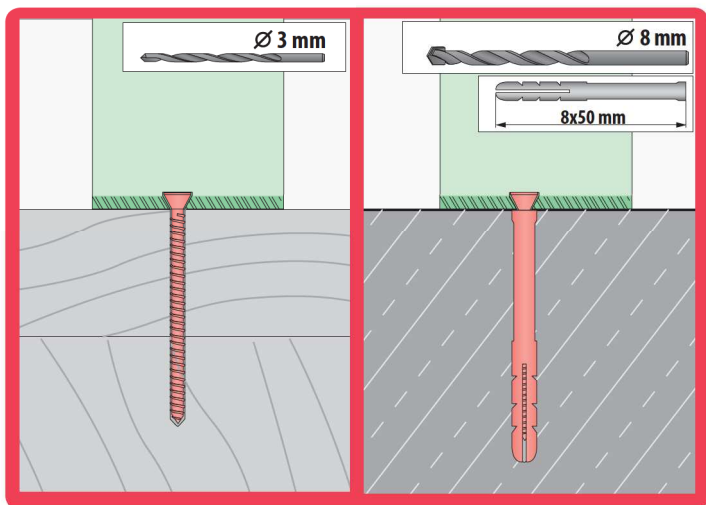

! WARNING! - ACHTUNG! - UWAGA! - ATTENTION! - CUIDADO! - ВНИМАНИЕ!

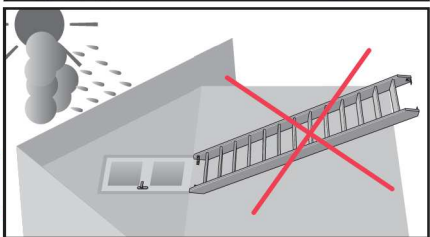
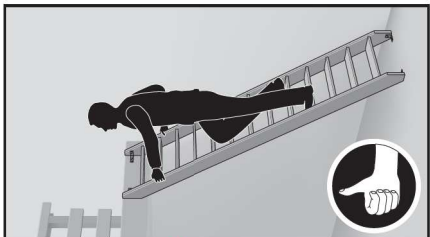
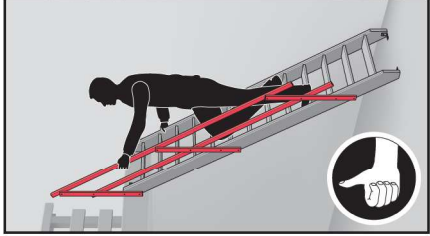
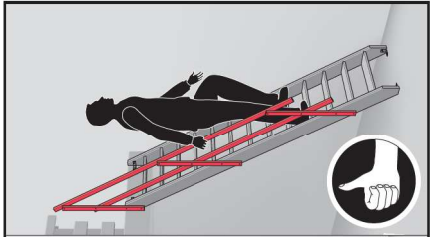
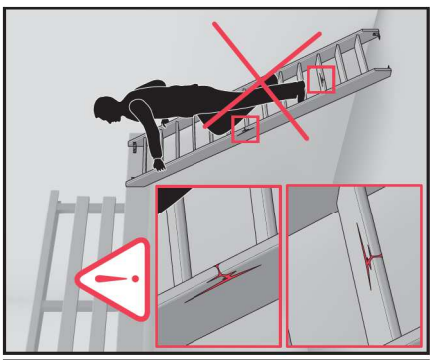

BG	Производител и Продавец не носят отговорност за неспазване на съответните закони, строителни норми и изисквания за безопасност от потребителя на продукта, архитекта, монтажника или собственика на сградата.	IT	Il Produttore e il Rivenditore non potranno essere ritenuti responsabili per il mancato rispetto, da parte dell'utente del prodotto, del progettista, dell'installatore o del proprietario dell'edificio, delle leggi vigenti, nonché dei regolamenti edilizi e di quelli relativi alla sicurezza.
CZ	Výrobce ani prodejce nenesou žádnou odpovědnost za nedodržení příslušných platných zákonů, stavebních předpisů a bezpečnostních požadavků uživatelem výrobku, architektem, montážníkem nebo vlastníkem budovy.	NL	De fabrikant en verkoper zijn niet aansprakelijk voor gevolgen bij het niet opvolgen van toepasselijke wetten, bouwbesluiten en veiligheidsvoorschriften door de gebruiker van het product, de architect, de installateur of de eigenaar van het gebouw.
DE	Hersteller und Verkäufer übernehmen keine Haftung für Nichtbeachtung entsprechender Rechts- und Bauvorschriften sowie Sicherheitsanforderungen seitens Produktbenutzers, Architekten, Monteure oder Gebäudebesitzers.	PL	Producent i Sprzedawca nie ponosi żadnej odpowiedzialności za nieprzestrzeganie stosownych przepisów prawa, przepisów budowlanych i wymogów bezpieczeństwa przez użytkownika produktu, architekta, montażystę lub właściciela budynku.
ES	El fabricante y el vendedor no tienen ninguna responsabilidad por el incumplimiento de la ley vigente, normas de construcción y exigencias de seguridad por parte del usuario del producto, arquitecto, instalador o el propietario del edificio.	PT	O fabricante e o vendedor não tem nenhuma responsabilidade pelo o não cumprimento da lei, códigos de construção e as exigências de segurança por parte do usuário do produto, arquiteto, instalador ou proprietário do edifício.
FR	Le fabricant et le revendeur ne prend aucune responsabilité de ne pas respecter les lois applicables, les règlements sur les bâtiments et les exigences de sécurité par l'utilisateur du produit, l'architecte, l'installateur ou le propriétaire du bâtiment.	RO	Nici producătorul, nici distribuitorul nu își vor asuma niciun fel de răspundere pentru nerespectarea legilor în vigoare, a legilor din domeniul construcțiilor sau a măsurilor de siguranță impuse utilizatorilor produsului, arhitecților, montajonilor sau proprietarilor clădirii.
GB	Manufacturer and Seller shall bear no liability for failure to comply with the applicable laws, building codes and safety requirements by the user of the product, architect, fitter or owner of the building.	RU	В случае несоблюдения архитектором, монтажником или владельцем здания строительных правил и норм безопасности ответственность с производителя и продавца снимается.
HU	A Gyártó és a Forgalmazó nem vállal semmiféle felelősséget a vonatkozó törvényi, építési és biztonsági előírások termékelhasználó, építész, beépítőmester vagy épületajánlódonos általi be nem tartásáért.	SK	Výrobca a predajca nenesú žiadnu zodpovednosť za nedodržanie príslušných ustanovení zákona, stavebných predpisov a bezpečnostných požiadaviek užívateľom výrobku, architektom, montérom alebo majiteľom objektu.